

513

Look ahead!



ENGLISH

Electric wire rope hoists

Chain Hoists

Crane components

Look ahead!



10 18 22 26

Crane components
CraneKitEX 

Electric chain hoists
SKex 

Hand chain blocks
CRAFTsterEX 

Electric wire rope hoists
NOVAex 

03 05
Look ahead!
Products 

Content

SWF is one of the leading global players in crane and hoisting equipment. At all times and in all places, SWF applies to the highest and the most demanding standards – those of our customers.

Our customers are independent crane manufacturers, lifting equipment resellers and service companies. They use SWF hoists and components because they perform better, offer advantages and can do more than the average products on the market. Quick decisions and flexible acting makes it easy to deal with SWF furthermore.

Close to every SWF product there stands a reliable local partner who knows precisely what counts. In this way installations are built to perform better, systems to work and last longer – systems with first class service and optimum efficiency, ideally customized to the end users needs.

No one can match what we have to offer.

SWF has one of the most comprehensive product portfolios available. In addition to that we also have a complete service package which includes seamless support, customer specific configuration software, technology and sales training, and a whole range of customer-oriented

services. We know that our partners will have to offer more than just products to have a competitive edge, and SWF helps them to get it. In the development of our EX crane components, the focus was made clear: the highest safety combined with reliability and the best quality. Our EX standard components are distinguished by having great flexibility and can be combined in the twinkling of an eye for on-demand solutions. Industrial manufacturing unites the high-class processing of all components with optimum quality management and ensures the highest cost efficiency.

Development going in one direction – upwards.

SWF was founded in 1921 in Germany and has since then been known to deliver high-quality products. Today, products from SWF are used in areas where top performance and top quality are demanded. Performance and quality that today's companies need in order to be successful and dependable.

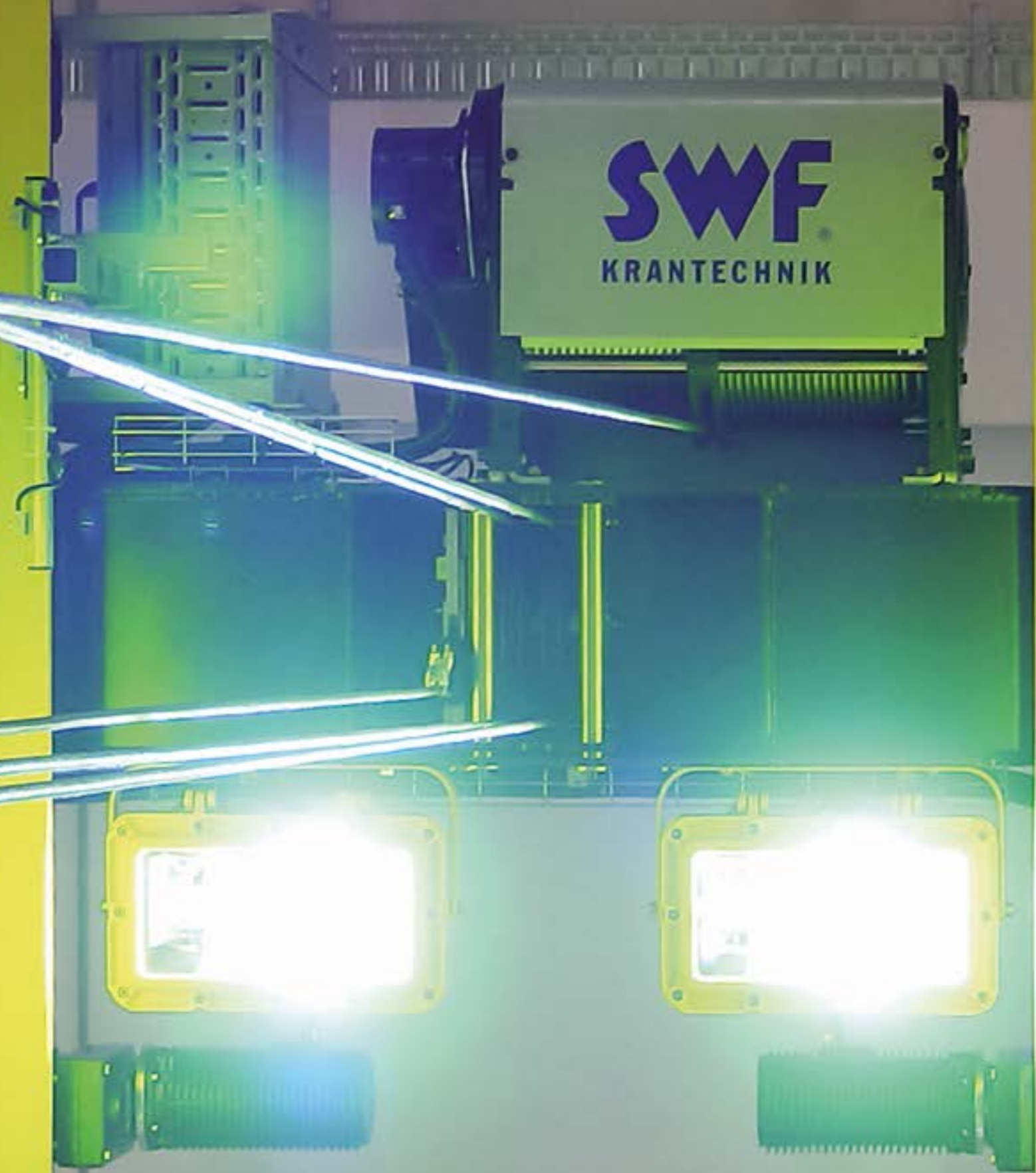
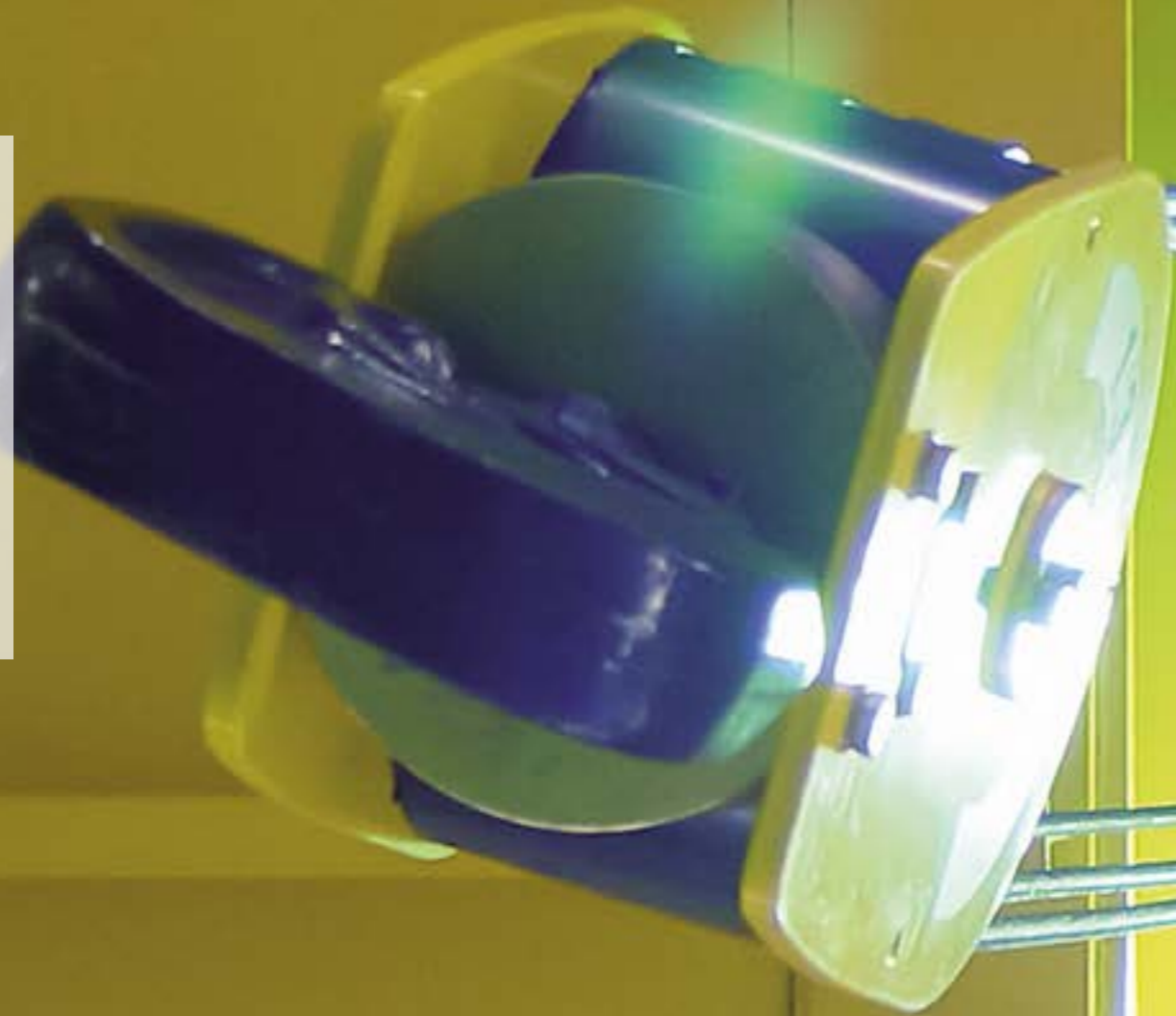

 Products



Explosion proof crane components for loads up to 80 t

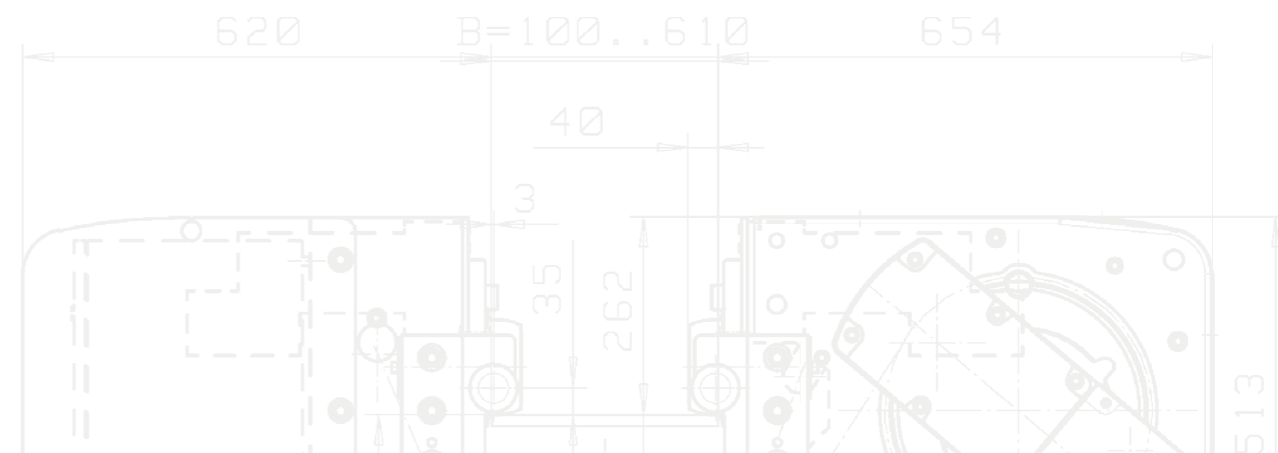

Explosion protection with SWF crane components

For our explosion proof hoists and crane components, we exclusively use high-quality components that comply with the applicable directives. The safety of the entire plant in subsequent operation comes first.

The product line ranges from hand chain blocks to the pre-configured CraneKit crane component package for efficient and reliable crane construction. Zones 1 and 2 or 21 and 22 are covered according to requirements with the product programme and so safe and dependable solutions are enabled for a variety of sectors and areas of application.

Application and certificates

Wherever dust and gases can occur during operation or production, explosion proof crane components by SWF are used depending on the requirements.

Our EX hoists fulfil the highest safety standards. They comply with the EU directives 94/9/EC (ATEX), the FEM regulations, the IEC 60079-14 standard and the European safety standards (EN).

Gas, mist and vapours:

- Chemical industry
- Refineries
- Gas supply
- Pharmaceutical industry
- Wastewater treatment
- Distilleries
- Mining
- Production plants
- ...

Dusts:

- Silo plants
- Mills
- Wood processing
- Paint shops
- Grinding workshops
- Feed production plants
- Bulk materials
- Synthetic fibre production
- ...

Transition from Directive 94/9/EC to Directive 2014/34/EU (ATEX)

Directive 2014/34/EU* applies from 26th February 2014 for devices and protective systems intended for use in potentially explosive areas. It replaces Directive 94/9/EC**.

The products that are placed on the market before 20th April 2016 need an EC Declaration of Conformity in accordance with Directive 94/9/EC. They can also be further provided with this EC Declaration of Conformity after 20th April 2016 on the market (concerns stocks that are already in the distribution chain; see also Recital 49).

The products that are marketed or are first put into operation after 20th April 2016 require an EU Declaration of Conformity in accordance with Directive 2014/34/EU.

Classification and allocation of potentially explosive areas for gases and dusts

To determine the necessary safeguards in potentially explosive areas, these are divided into zones. For this, key factors are the frequency and duration of the presence of potentially explosive atmospheres with gases and vapours, as well as with dusts.

Zone		Probability of an explosive atmosphere
Gases	Dusts	
0	20	Very high – explosive atmosphere is continual or very frequent
1	21	High – explosive atmosphere is occasional
2	22	Low – explosive atmosphere rarely occurs



Explosion proof crane components for loads up to 80 t



08

09

Motors

Powerful hoist and travel motors also form with explosion proof cranes the heart of all electric chain and electric wire rope hoists. These must often prove their precise function in daily work for decades.

In explosive atmospheres, the protection of the motors for Zone 1 and Zone 21 is combined from a pressure resistant enclosure (d), increased safety (e) and the protection by the housing (tD).

For Zone 2, the motors are manufactured according to protection class „Non-sparking equipment“ and for Zone 22 motors are available in IP 66 and „Protection by housing (tD)“.

Electrical cubicles

Crane and trolley control panels that house the electrical control and regulation components are robust according to the area of application and are designed in the protection class „Pressure resistant encapsulation (d)“, „Increased safety (e)“ or „Protection by housing (tD)“. Generously proportioned housing covers ensure the necessary encapsulation and at the same time make the installation and maintenance tasks easier.

Cable entry points

Indirect cable entry points provide a very high level of security in terms of the protection classes „Pressure resistant encapsulation (d)“ and „Increased safety (e)“.



Control pendants

Especially in explosive atmospheres, a safe and reliable control of the load is indispensable. Trolley and crane travelling can be carried out slowly and accurately or quickly and efficiently thanks to the two-stage rocker switches. Smooth running and functionally arranged switching elements always hereby give the crane operator the necessary control of the crane and the load.

The especially robust design of the control pendants was conceived explicitly for application in explosive atmospheres. Hoists and cranes with contactor control thus remain reliably controllable even under the most difficult conditions.

An EMERGENCY-STOP pushbutton is standard equipment of all control pendants.

Load hooks

To ensure spark protection from contacts of the load hook, for example, with lifting equipment, the load hooks are optionally coated with bronze.

Running wheels

For a variety of applications in explosive atmospheres, robust and long-lasting running wheels from cast iron can be used. In special cases, from 1 m/s onwards, running wheels from solid brass material are optionally available for additional spark protection (increased maintenance requirement).



NOVAex 
Electric wire
rope hoists



NOVAex

Electric wire rope hoists for loads up to 80 t

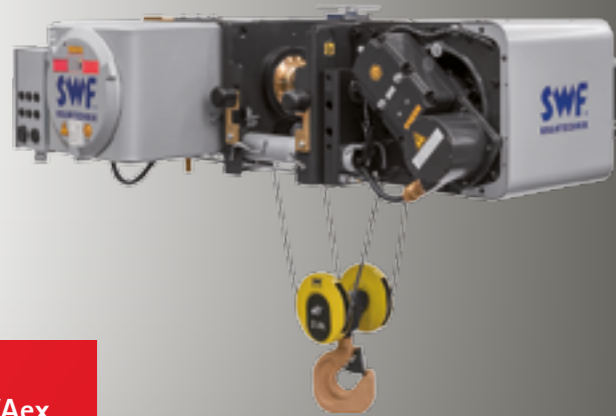

- **Optimum utilisation of space**
Compact installation dimensions and optimum approach dimensions, minimum hook dimensions
- **Precise and safe work**
Minimum lateral hook movements, robust contactor control for 2-step travelling and lifting
- **Low maintenance costs**
The brake designed to extend the lifetime, the larger diameter of the rope drum to protect the load rope, the hoist gear lubricated to extend the lifetime

NOVAex

Perfect utilisation of space and almost vertical lifting guarantee so that work is carried out precisely and safely.

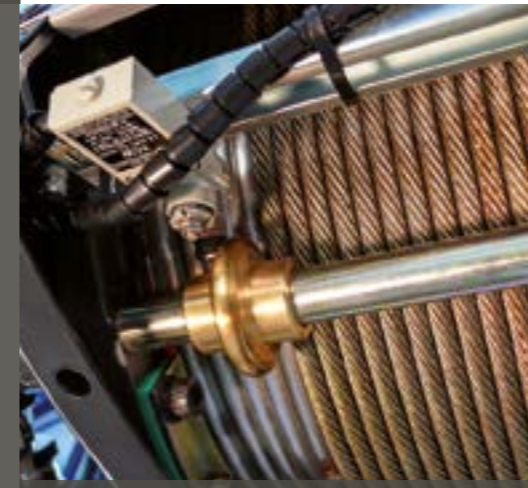

Rope guide

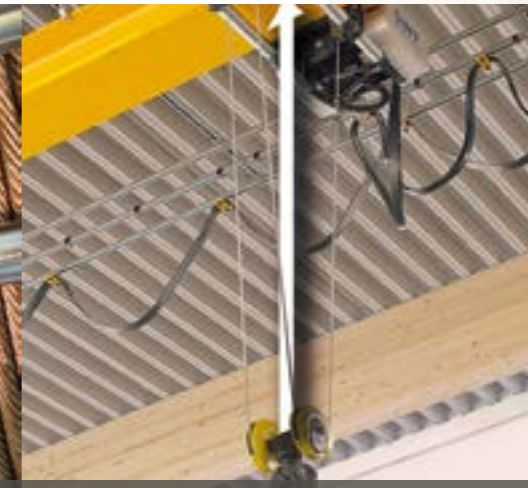

Minimum hook travel



Best approach dimensions

Advantage: Maximum safety and optimum utilisation of space

- Loads up to 80 t
- Single hoist or as CraneKit
- Single or double girder trolley or foot-mounted hoist
- Robust contactor control, 2-step
- Low lateral hook movement
- Compact installation dimensions
- Optimum approach dimensions
- Ambient temperature -10°C up to +40°C

We have increased the size of the drum, making everything else smaller.

The main feature of our NOVA electric wire rope hoist is the extremely large diameter of the rope drum, which provides first-class protection of the rope, but there are also other features which guarantee safe and very cost-effective use.

NOVA does away with load swinging and lateral hook movement, for example.

NOVA lifts the load with virtually no lateral hook movement at all. Swinging of the load is prevented and secure handling is guaranteed. At the same time, this can help to reduce the costs for the crane design.

NOVA adapts itself to your building.

NOVA offers the best approach dimensions and the smallest installation dimensions in the electric wire rope hoist sector. This ensures the optimum utilisation of space and reduces building costs.

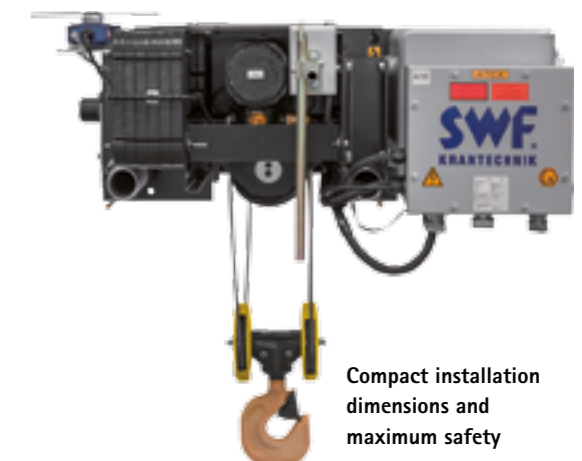

Compact installation dimensions and maximum safety

Electric wire rope hoists for loads up to 80 t

Optimum utilisation of space
Precise and safe work

NOVAex



Hoist gear and hoist limit switch designed according to ATEX

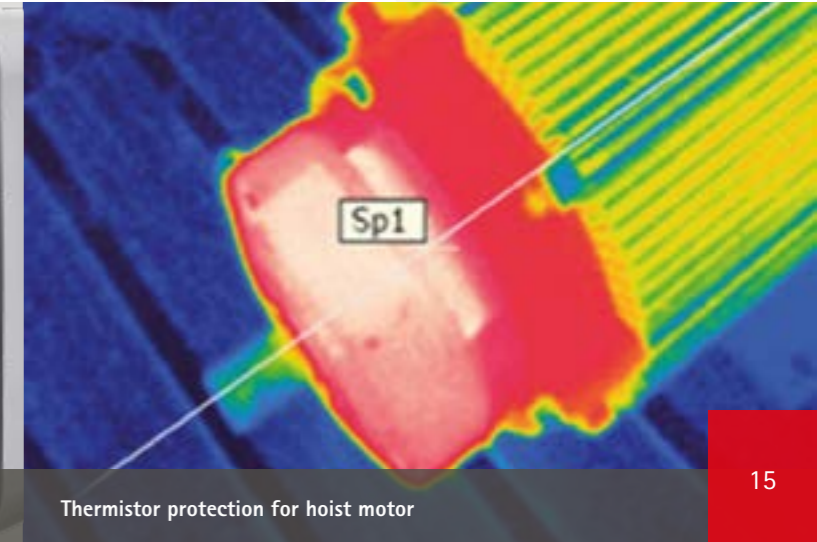

Thermistor protection for hoist motor

Standard equipment

Electric wire rope hoist NOVAex :

- 2-speed hoisting motors (6:1)
- 2-speed travelling (4:1)
- Thermal protection for hoisting and travelling motors
- 2-step limit switch
- Electromechanical overload protection
- Operating time counter
- Cables readily placed and positioned
- Special HBC load hooks
- Two-component powder coating
- Ambient temperature -10°C up to +40°C

Options

Electric wire rope hoist NOVAex :

- Running wheels and fall protection made of brass
- Load hooks coated with bronze
- Radio remote control RadioMaster
- Maintenance platform
- Second hoisting gear brake NC-ND
- Drum brake NE-NF
- DIN or double load hooks
- Cable pressure roller
- Ambient temperature -20°C or +50°C
- Ambient temperature +55°C on demand

Motor zone 1-21

- ATEX II2G/D c Ex de IIC T4
- Completely closed, cooled with fan
- PTC thermistor
- Pressure resistant encapsulation (d)
- Insulation class F, Protection rating IP66
- Brake designed to extend the lifetime

Motor zone 2-22

- ATEX II3G/D c Ex nA IIB T3
- Standard "nA" motor
- PTC thermistor
- Insulation class F, Protection rating IP66
- Brake designed to extend the lifetime



Load hook coated with bronze

Application areas:

Gas zones		
EX zone 1 II 2G	Gas group IIB	Temperature class T4 (135°C)*
EX zone 1 II 2G	Gas group IIC	Temperature class T4 (135°C)*
EX zone 2 II 3G	Gas group IIB	Temperature class T3 (200°C)*
EX zone 2 II 3G	Gas group IIC	Temperature class T3 (200°C)*
Dust zones		
EX zone 21 II 2D	Dust group IIIC	Temperature class T135°C*
EX zone 22 II 3D	Dust group IIIC	Temperature class T135°C*

* Maximum permissible surface temperature. Subject to change without notice.

Electric wire rope hoists for loads up to 80 t



Potential equalisation using earthing strap

Potential equalisation at EX crane systems

The installation of electrical systems in potentially explosive areas basically requires a variety of prevention measures. An indispensable protective precaution here is the potential equalisation of all live components. All components of the crane that can be live in the case of failure are connected together and then finally to the protective conductor.

The need for this measure has also not remained unnoticed by the CraneKit and relevant components supplement and complete the component base. With our EX hoists, the grounding cables are already mounted ready for operation at the factory and thus grant an easier commissioning.

In practice, not only are all electric components to be earthed without exception, but also the entire crane installation, like auxiliary structures, runways, supports, etc., is to be included in the protection measure. For reliable equalisation, for example even runway joints must thus be conductively bridged (support joints with link plates bolted over are not enough here).

Schematically illustrated is the grounding on the crane bridge via the running wheels of the crane trolley and on the crane bridge via the running wheels of the end carriage and then finally to a suitable earthing point / conductor.

Enclosed electrical cubicles for crane and trolley control

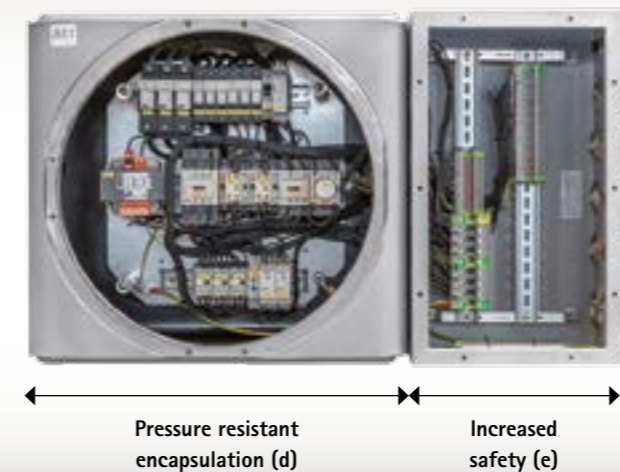

Electrical cubicles and cable entry points

The crane and trolley control panels accommodate control, measurement and automation systems for reliable and safe load handling. Control panels in the standard DE are divided into different security areas/zones and combine „Pressure resistant encapsulation (d)“ and „Increased safety (e)“.

The advantages of this implementation are reflected not only in economic aspects, but also with respect to highest possible safety and easier handling. Thus an opening of the area „Pressure resistant encapsulation (d)“ is not necessary during the installation. All connections necessary in this zone have already been made at the factory by certified specialist staff and under optimum conditions.

A robust inspection cover, to be opened by means of screwable ball handles, ensures the fastening of the zone „Pressure resistant encapsulation (d)“.

All necessary first installation steps and cable entry points are carried out user-friendly, only in the area „Increased safety (e)“, and the zone „Pressure resistant encapsulation (d)“ can remain reliably closed.

Cable and conduit entry points produce a solid and tight connection and in addition offer advanced protection against mechanical influences. All cable screw connections/terminals therefore provide a very high level of safety and guarantee the proper functioning of the electrical equipment.



SKex 
Electric chain hoists



- **Optimum utilisation of space**
Compact installation dimensions and optimum approach dimensions
- **Precise and safe work**
Minimum lateral hook movements, robust contactor control for 2-step travelling and lifting
- **Low maintenance costs**
Robust industrial design, standardised assemblies, easy accessibility

Advantage: Efficient and economical operations with the highest safety

Flexible, powerful and compact.

In our SKex series, we have packed high-performance motors into a compact design. The extremely sturdy construction guarantees long service life, reliable operation and low wear, maintenance and service costs. The SKex series is equipped with a low-voltage control system and complies with all relevant safety requirements for modern lifting gear. These high quality chain hoists are particularly suitable for a wide range of special applications.

Standard equipment electric chain hoist SKex :

- Upper hook
- 2 lifting speeds (4:1)
- Robust contactor control, 2-step
- Lifting and travelling overheating protection
- Slipping clutch as overload protection
- Two-component powder coating
- Galvanised load chain
- Ambient temperature -20 up to +40°C
- Derailment catches and rubber buffer included



SKex with upper hook



Control pendant and hoist motor

Options electric chain hoist SKex :

- Push trolley
- Motor trolley, two travelling speeds (4:1)
- Running wheels and fall protection made of brass
- Hook coated with bronze
- Gear limit switch
- Special paint finish to 240µm
- Power supply with flat cable
- Protection rating IP66
- Ambient temperature -20 bis +50°C
- Stainless steel load chain, hook and hook block

Motors:

- Conical motor, completely closed, cooled with fan
- PTC thermistor in winding and brake housing
- Pressure resistant encapsulation (d)
- Insulation class F, Protection rating IP54



Pressure resistant encapsulation

Application areas:

Gas zones		
EX zone 1 II 2G	Gas group IIB	Temperature class T4 (135°C)*
EX zone 1 II 2G	Gas group IIC	Temperature class T4 (135°C)*
Dust zones		
EX zone 21 II 2D	Dust group III C	Temperature class T120°C*
EX zone 22 on request		

* Maximum permissible surface temperature. Subject to change without notice.



CRAFTsterEX 
Hand chain blocks

CRAFTsterEX

Hand chain block for loads up to 20,000 kg



- Optimum utilisation of space**
 Compact design and minimum hook dimensions, handy for transportation to site of operation
- Flexible usage**
 Wide range of applications, low unit weight for gentle operation, independent to power supply, designed for heavy duty and loads
- High safety in operation**
 Robust industrial design, proven design, high quality interior parts

Advantage: Each time useable lifting equipment with high reliability

The hand chain block CRAFTsterEX is a reliable travel companion for safe lifting. It proves its ability not only under the most difficult conditions or in sensitive work environments, but also it is rather a mobile and flexible all-rounder. Without the need of an electrical connection and with up to 20 t of load capacity, it offers an autonomous alternative for electrically operated hoists for a wide range of tasks - and safe, reliable and long lasting.

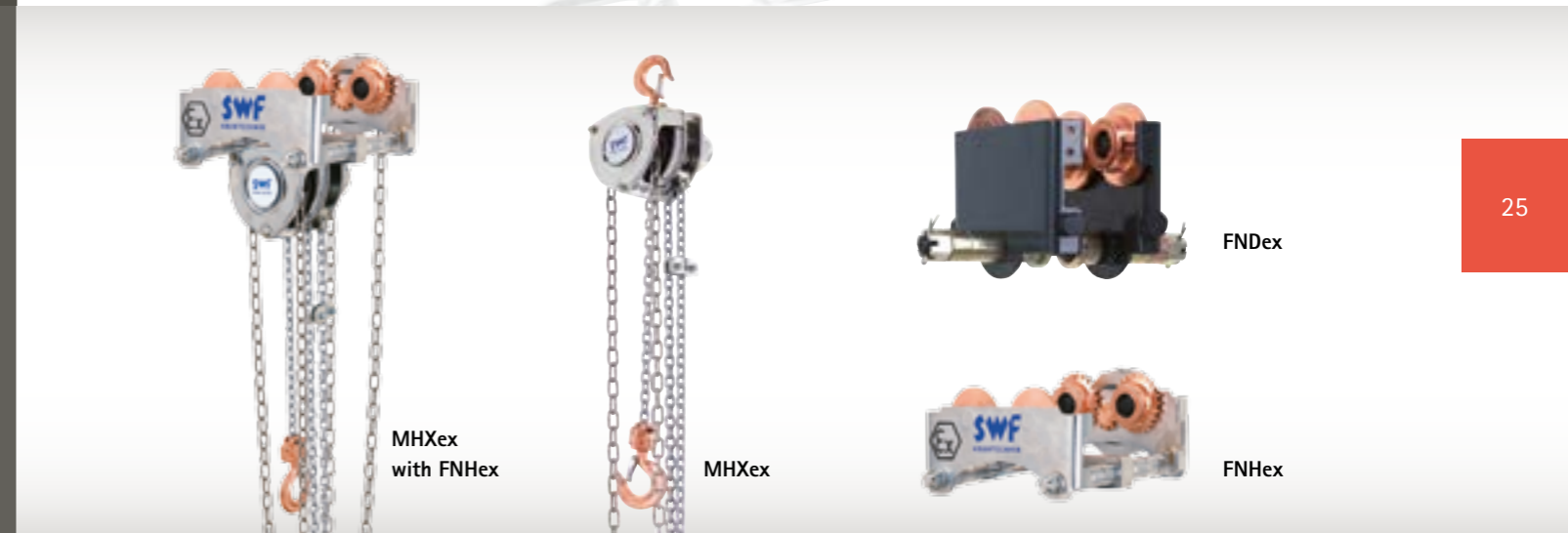

Standard equipment hand chain block MHXex :

- ATEX Labelling Gas EX II 2G c IIC T4
- ATEX Labelling Dust EX II 2D c T120°C
- Suitable for potentially explosive gas or dust atmospheres in Zones 1 and 2 or Zones 21 and 22
- Slipping clutch as overload protection
- Galvanised load chains, working height 3 m
- Hand chains made of stainless steel, working height 3 m
- Hooks coated with bronze
- DIN-ISO Hooks with hook safety catch

Standard equipment Push trolley/Chain driven trolley FNDex /FNHex :

- ATEX Labelling Gas EX II 2G c IIC T4
- ATEX Labelling Dust EX II 2D c T120°C
- Suitable for potentially explosive gas or dust atmospheres in Zones 1 and 2 or Zones 21 and 22
- Running wheels coated with bronze 60 µm
- Hand chains made of stainless steel, working height 3 m
- Rubber buffer

Application areas:

Gas zones		
EX zone 1 II 2G	Gas group IIC	Temperature class T4 (135°C)*
Dust zones		
EX zone 21 II 2D	-	Temperature class T120°C*

* Maximum permissible surface temperature. Subject to change without notice.

SWF[®]
KRANTECHNIK



CraneKitEX Crane components

CraneKitEX

Crane components for loads up to 80 t

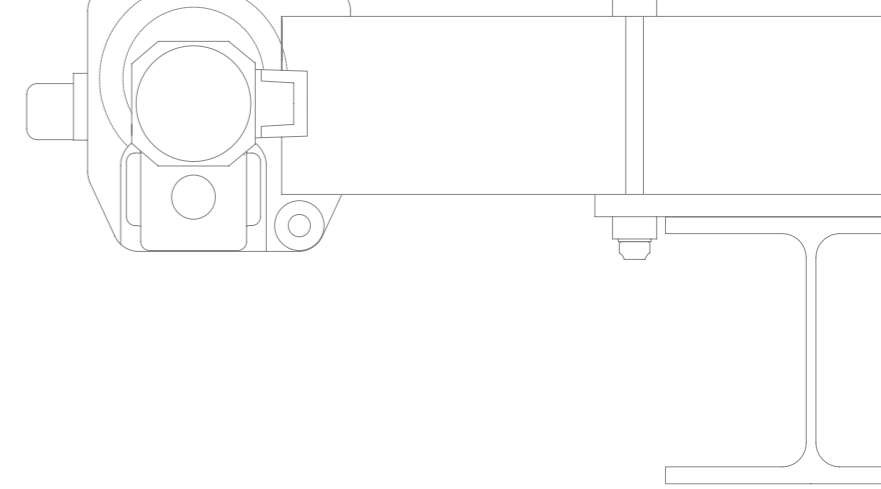

- **High safety and efficiency**
One-Stop-Shopping principle: All components from one source provide for safe and reliable interaction
- **Shorter assembly times**
Pre-designed, pre-assembled and pre-wired components with screw and plug connection (plug and socket)
- **Numerous variations**
A well planned standard component basis, depending on the usage with electric chain or electric wire rope hoist, crane calculation support via CraneMaster software



Prewired hoist trolley power supply



Double girder overhead bridge crane with crane lights

Advantage: a complete crane in an "All-Round-Carefree-Package", Power – out of the box

- CraneKitEX contains all components required for the construction of an EX crane, except the crane bridge
- Flat cable power supply lines are pre-manufactured and pre-wired
- Pre-manufactured electrical system
- EC Declaration of Conformity for the complete CraneKitEX contains:
 - Hoist
 - Power supply for hoist and crane
 - End carriages
 - Travelling machineries
 - Cables, terminal boxes, bridge panels, towing arm

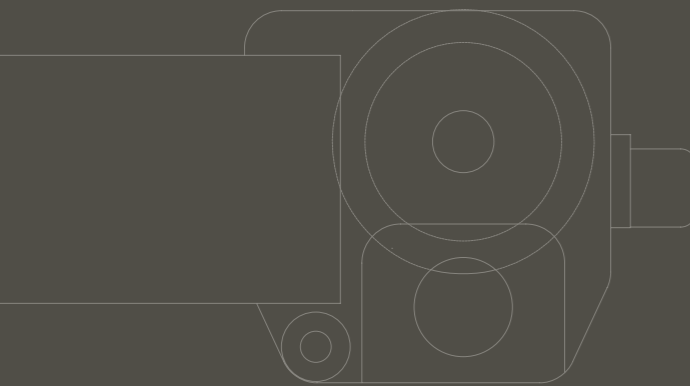

End carriage

Standard equipment crane components CraneKitEX :

- Freely movable control pendant (EEx IIC T6) with two-stage rocker switches
- Crane control panel Ex de IIB T5/T6
- 1-step crane travelling limit switches
- Terminal box for connecting the riser pipe
- Riser pipe
- Main switch Ex d IIC T6 / IIB T6

Options crane components CraneKitEX :

- Radio remote control (RadioMaster)
- Crane control panel Ex de IIC T5/T6
- 2-step crane travelling limit switches
- Terminal boxes
- Crane lights for bridge
- Horn 108dB at 1m distance
- Signal lamp

Standard content can include:

- 1 Hoist power supply with flat cable or energy chain
- 2 Control pendant with EMERGENCY-STOP
- 3 Radio remote control including transmitter and receiver
- 4 Electric hoist
- 5 Trolley and crane travelling limit switches
- 6 Crane control panel
- 7 Crane lights for bridge
- 8 Horn
- 9 End carriages with travelling machinery

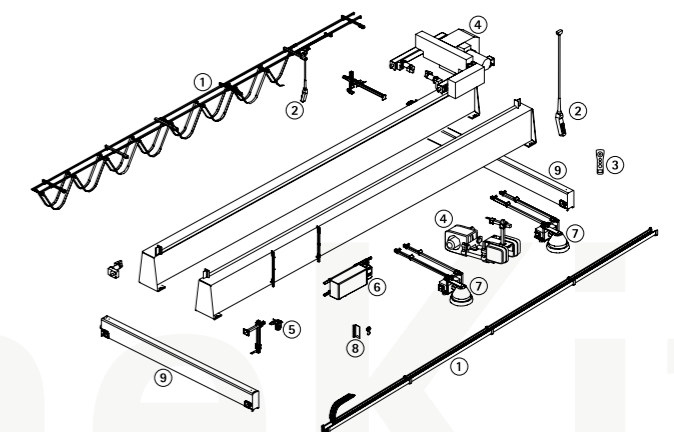

CraneKitEX

Crane components for loads up to 80 t

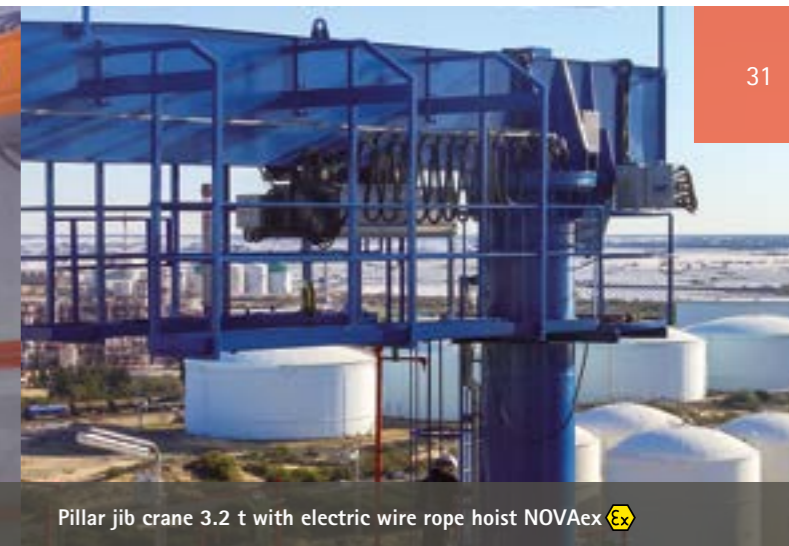
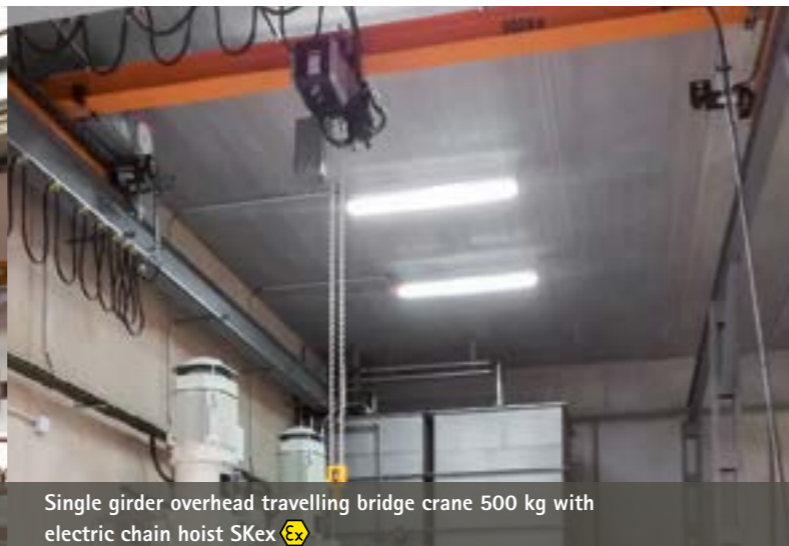
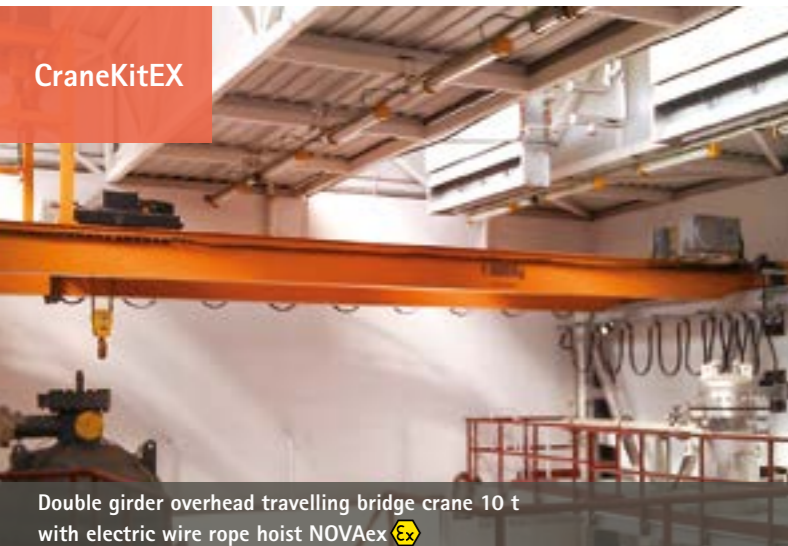



CraneKitEX

31

Double girder overhead travelling bridge crane 10 t with electric wire rope hoist NOVAex 

Single girder overhead travelling bridge crane 500 kg with electric chain hoist SKex 

Single girder overhead travelling bridge crane 6.3 t with electric wire rope hoist NOVAex 

Pillar jib crane 3.2 t with electric wire rope hoist NOVAex 

Main switch / safety switch

During cleaning and repair work, the safety switches take over the inevitable separation of the electric power supply from equipment in potentially explosive areas. The safety switches are approved for use in potentially explosive areas of Zones 1, 2, 21 and 22.

Terminal boxes

The terminal boxes are explosion proof equipment for permanent installation. They are used in potentially explosive areas for distributing electric energy. The housings are made of fibreglass-reinforced polyester resin in different sizes. They are combinable with each other for more extensive distributions.

End carriages and travelling machineries

Numerous design variants of end carriages and travelling machineries are available for operation in explosive atmospheres. For new systems as well as modernisations, this allows coordination depending to the requirements. Single and double girder overhead bridge cranes are tailor-made without great effort for individualists.

Crane lights

Safety during crane operation is noticeably increased by good illumination. The explosion proof designs allow the lighting of surfaces, work areas and objects in the inside and outside areas. Mounted in fixed positions, they can be used in Zones 1, 2 and 21, 22, as well as in safe areas.

Signal lamps and horn

Through the optical and acoustic identification of different system states, the EX signal lamp and EX horn increase the safety for the crane and trolley operation. They signal to the crane operator, for example, an overload or the activation of the radio control and so contribute to the avoidance of accidents.

Different light modes and colour caps of the signal lamp allow optimum customisation for the respective requirements.

The 108 db loud EX horn is manufactured from either aluminium or polycarbonate.

The compact and encased EX components offer protection against mechanical damage and external influences thanks to their robust housings, and this also includes first-class corrosion protection.



Look ahead!



654

610

B=1000

40

620

05/2016 - WWW.RALF-GROSSE-SCHULTE.DE

ENGLISH

SWF Krantechnik GmbH

P.O. Box 310410
D-68264 Mannheim

Boehringerstr. 4
D-68307 Mannheim
Germany

Phone +49(0)621.78990-0
Fax +49(0)621.78990-100

info.de@swfkrantechnik.com
www.swfkrantechnik.com